

# Camera Solution Catalog

## Image Signal Processor Milbeaut®



### Socionext Inc.

Nomura Shin-Yokohama Bldg., 2-10-23 Shin-Yokohama, Kohoku-ku,  
Yokohama, Kanagawa, 222-0033, Japan  
Tel. +81-45-568-1015

<http://socionext.com/en/>

All Rights Reserved.  
Socionext Inc., its subsidiaries and affiliates (collectively, "Socionext") reserves the right to make changes to the information contained in this document without notice. Please contact your Socionext sales representatives before order of Socionext device.  
Information contained in this document, such as descriptions of function and application circuit examples is presented solely for reference to examples of operations and uses of Socionext device. Socionext disclaims any and all warranties of any kind, whether express or implied, related to such information, including, without limitation, quality, accuracy, performance, proper operation of the device or non-infringement. If you develop equipment or product incorporating the Socionext device based on such information, you must assume any responsibility or liability arising out of or in connection with such information or any use thereof. Socionext assumes no responsibility or liability for any damages whatsoever arising out of or in connection with such information or any use thereof.  
Nothing contained in this document shall be construed as granting or conferring any right under any patents, copyrights, or any other intellectual property rights of Socionext or any third party by license or otherwise, express or implied. Socionext assumes no responsibility or liability for any infringement of any intellectual property rights or other rights of third parties resulting from or in connection with the information contained herein or use thereof.  
The products described in this document are designed, developed and manufactured as contemplated for general use including without limitation, ordinary industrial use, general office use, personal use, and household use, but are not designed, developed and manufactured as contemplated (1) for use accompanying fatal risks or dangers that, unless extremely high levels of safety is secured, could lead directly to death, personal injury, severe physical damage or other loss (including, without limitation, use in nuclear facility, aircraft flight control system, air traffic control system, mass transport control system, medical life support system and military application), or (2) for use requiring extremely high level of reliability (including, without limitation, submersible repeater and artificial satellite). Socionext shall not be liable for you and/or any third party for any claims or damages arising out of or in connection with above-mentioned uses of the products.  
Any semiconductor devices fail or malfunction with some probability. You are responsible for providing adequate designs and safeguards against injury, damage or loss from such failures or malfunctions, by incorporating safety design measures into your facility, equipments and products such as redundancy, fire protection, and prevention of overcurrent levels and other abnormal operating conditions.  
The products and technical information described in this document are subject to the Foreign Exchange and Foreign Trade Control Law of Japan, and may be subject to export or import laws or regulations in U.S. or other countries. You are responsible for ensuring compliance with such laws and regulations relating to export or re-export of the products and technical information described herein.  
All company names, brand names and trademarks herein are property of their respective owners.

# TO THE TOP OF HIGH-QUALITY IMAGING



## Milbeaut's solutions for imaging

"Milbeaut®" is a high quality imaging processor with track record of DSLR, smartphones, surveillance camera and other various cameras since its start-up in 2000. Socionext will provide various imaging solution based on our experience in image processing technology accumulated with Milbeaut's 15 years of history.

▶ Surveillance Camera

▶ Drone / Action Camera

▶ IoT Camera

▶ Digital Still Camera and

# Surveillance Camera Solution

We provide camera solutions fit for surveillance use, packaging useful features including scene detection, haze removal, tampering detection, camera motion detection, motion detection, intrusion detection, cross line detection, and video HDR to low-power, light-weight ASSP equipped with various functions necessary for camera.



## 360 Degree All-Around Surveillance Solution

We can apply necessary functions such as distortion correction, crop, super-resolution zoom, and panoramic to 360 degree camera image, allowing output image to be customized in accordance to camera location and usage.

## Total Surveillance Camera Solution in 4K

From camera input to NVR, we provide total surveillance camera solution in high quality 4K image. Our system is capable of facial/object recognition, identification and zooming in clear and detailed 4K image, realizing surveillance system with high performance and wider vision.

### example(4K2K surveillance camera)

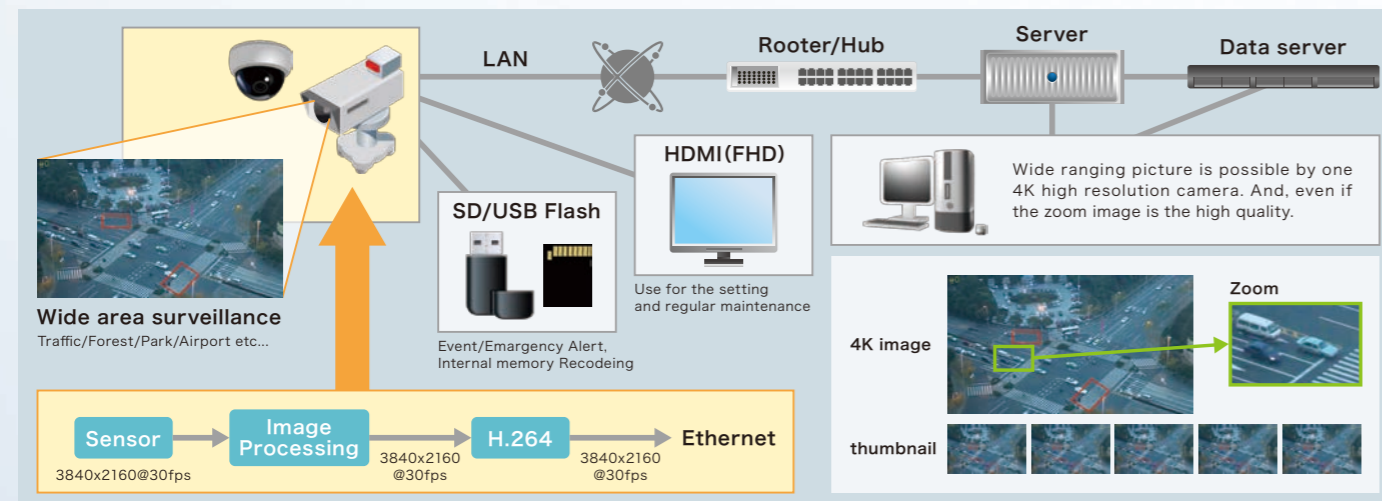

## Main Features

### Motion Detection/Tracking and Anomaly Detection

Our system has a motion detection feature which can be used in various situations, such as monitoring traffic and/or pedestrians on streets, tracking moving vehicles, etc. Also, with tampering and camera shake detection, camera troubles can be detected and alerted smoothly.

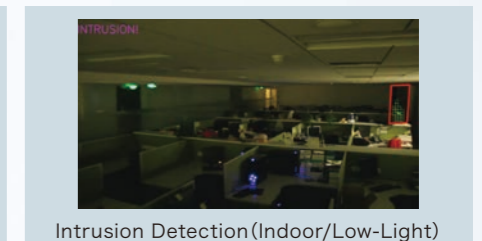
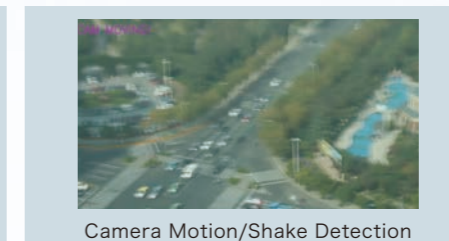
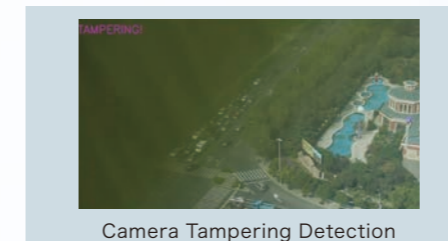
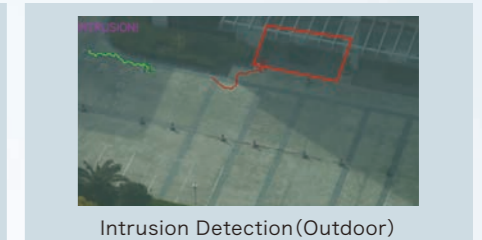
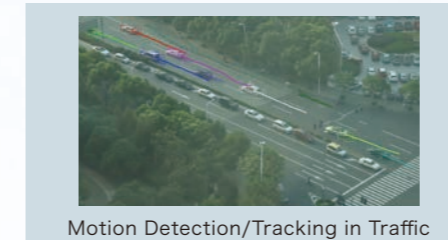

### Haze Removal

In cases where camera is set on high, far locations, weather conditions such as mist, rain, and snow may be obstacles to getting correct images. Our Haze Removal feature is useful in such condition where it detects and removes only the haze part, outputting clear image. Haze Removal clears out the haze but leaves background details such as smokes and clouds.

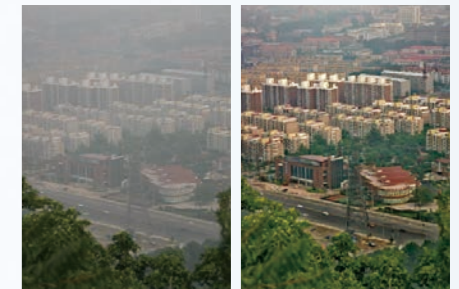

### Video HDR

In backlight scenes where subject tends to be overexposed/underexposed, HDR function adjusts luminance levels and brings out detailed, vivid image. Available in 1920x1080/30fps.



## Product Lineup

### Milbeaut®

Product	Features
MB86S27	4K/30p, H.264, 360° distortion correction
MB91696B	1080/30p, H.264

### Others

Product	Features
MN2WS0230	1080/30p 3CH, 720/60p 4CH
MN2WS03101	4K/60p, H.265

## Major IPs

- EIS(Electronic Image Stabilization)
- Video HDR Processing
- Face Detection/Recognition
- Haze Density Detection(Auto)
- Haze Removal/Correction
- Noise Reduction
- Optimization of High Sensitivity
- 3DNR

# Drone/Action Camera Solution

With Milbeaut's image processing technology for capturing the best moment, we have means to reduce shakes and realize stabilized video recordings in action scenes such as bicycles and motorbikes. We support high quality image in active scenes on devices such as drone, drive recorder, and action cameras, providing perfect solutions for the latest trend market.

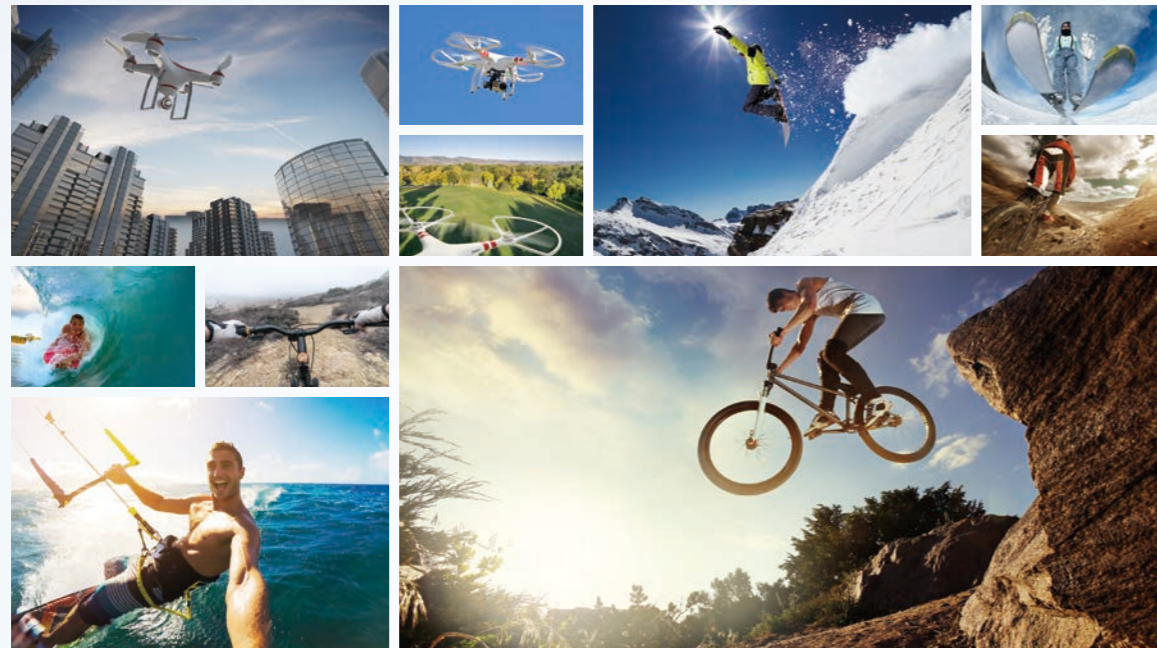

## Provides Best Shot Suiting Each Scene

Mounted with high-performance EIS suited for drone, action camera, drive recorders, etc., our system allows user to capture stable shots in action scenes. With other features including slow motion capture, suited for golf swing scenes, auto object-tracking feature「Follow me/Follow you」, Video HDR, and Haze Removal, we support high quality shooting in various scenes.

## Wrap-around View(Panorama Wrap-around)

360 degree video using fish-eye lens can be converted in real time by applying lens distortion correction to the image by parts. Video can also be viewed in panorama by setting larger horizontal size to cutout.

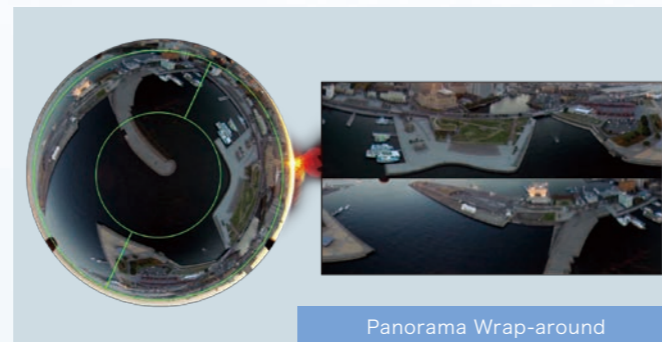
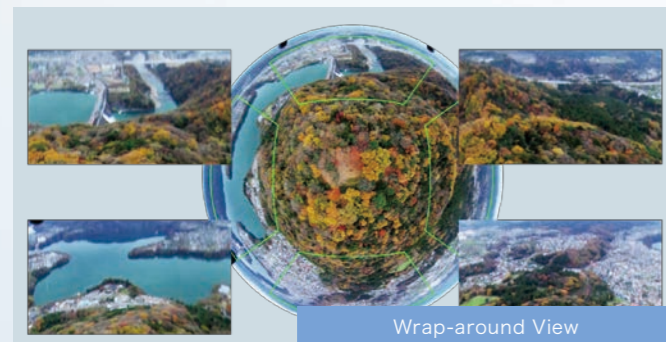

## Main Features

### EIS(Electronic Image Stabilization)

The EIS feature contributes to capturing beautiful images in action scenes.

#### Video EIS

Provides smooth and stable images for action camera and drive recorders, in which the camera body itself is in motion.

#### Rolling Shutter Correction

Detect and correct partial distortion caused by fast-moving objects. Can be combined with EIS to provide more stable video recordings.

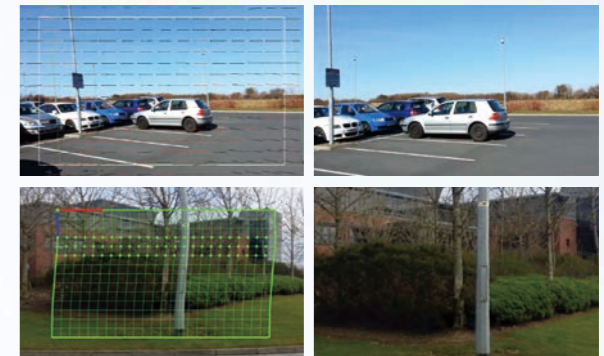

### Video HDR

Creates HDR image by alternately capturing(60 fps) short exposure and normal exposure images in full HD size(1920x1080) and merging them into one image internally. HDR reduces overexposure/underexposure in backlight, high contrast, or night scenes, bringing out detailed and vivid video images. Since it supports high speed, processing every frame, the Video HDR is very effective for drone and drive recorder cameras, where the camera is mostly moving around.

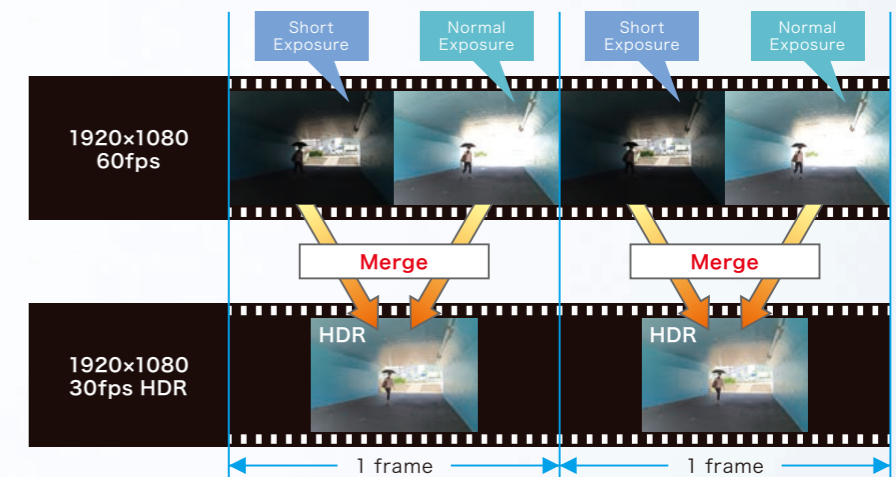

### Haze Removal

Under environment with poor visibility, such as rain or snow, Haze Removal can clear out the haze without removing the rain/snow itself. Also, rain droplets can be detected when falling upon camera, giving the camera an alert/trigger feature when it is wet or has vision troubles.

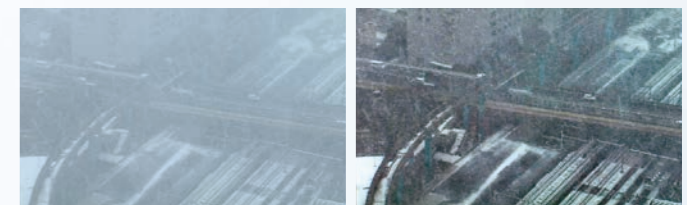

## Product Lineup

### Milbeaut®

Product	Features
MB86S27	4K/30p, H.264, 360° Distortion Correction
MB91696B	1080/30p, H.264

## Major IPs

- EIS(Electronic Image Stabilization)
- Video HDR
- Face Detect/Recognition
- Haze Density Detection(Auto)
- Haze Removal/Correction
- Noise Reduction
- Optimization of High Sensitivity
- 3DNR

# IoT Camera Solution

Even in camera systems with much optical limitations as mobile, Wearable, video conference system, PC camera, Milbeaut can use its resource to the max to produce high quality images. we provide cutting-edge technologies through features including high-level image processing, variety of product lineups from low cost to high-end are available.



## Dual Camera Solution

With smart phone camera in the lead, the need for dual camera, mounted with two sensors, is increasing in the mobile camera market. Features using dual camera, such as high quality image with mono and color sensor combination in low-light condition and DSLR-like background blur shots using depth map, allows mobile camera to take higher quality images beyond current level.

## Depth Map Generation Sequence

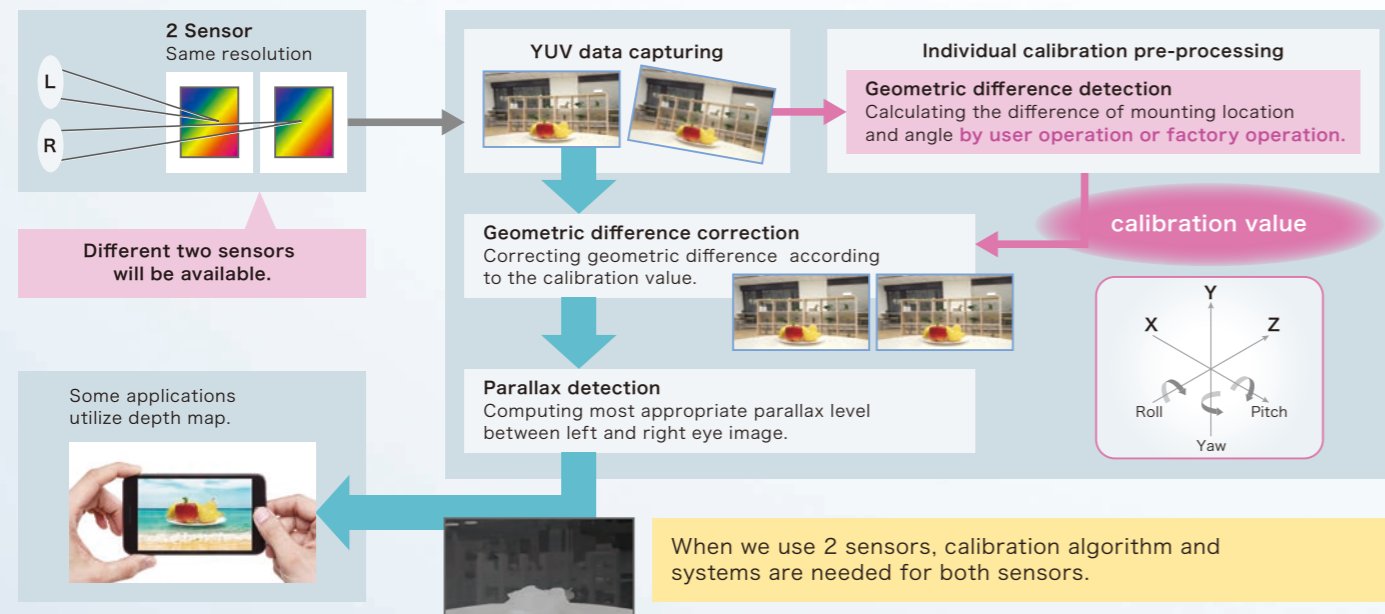

## Main Features

### Depth Map(Distance Information) Generation

The generated depth map can be applied to produce background blurs, post-focus control, and subject cropping.

#### Background Blur

Can capture DSLR-like photos with background blur. This feature can also be used by applications to create composite images.

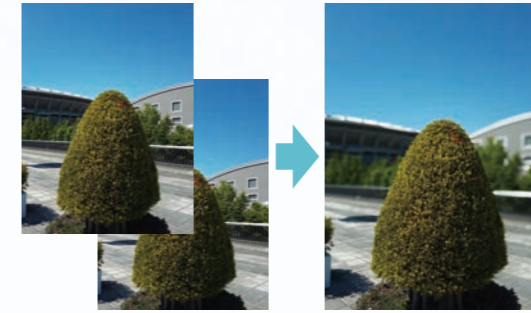

#### Post-Focusing

Allow user to change focal point after capturing. Focal point can be controlled in all ranges from infinity to macro to all-focused.

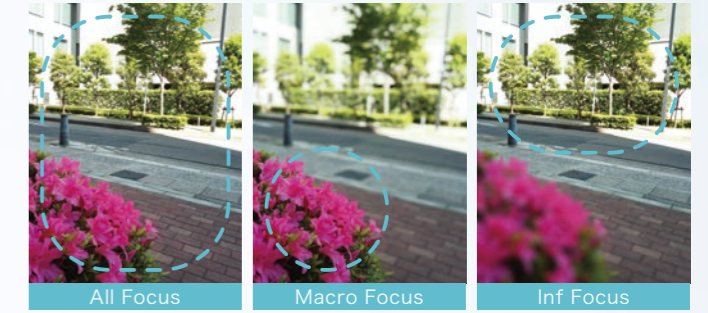

#### Low Light Shot

In cases where both mono and color sensors are connected, beautiful low-light image with less noise and high sensitivity can be produced combining color and high-sensitive mono input images with Milbeaut's unique algorithm. This feature is simple and useful for mobile camera, where low-light conditions are hard to capture.

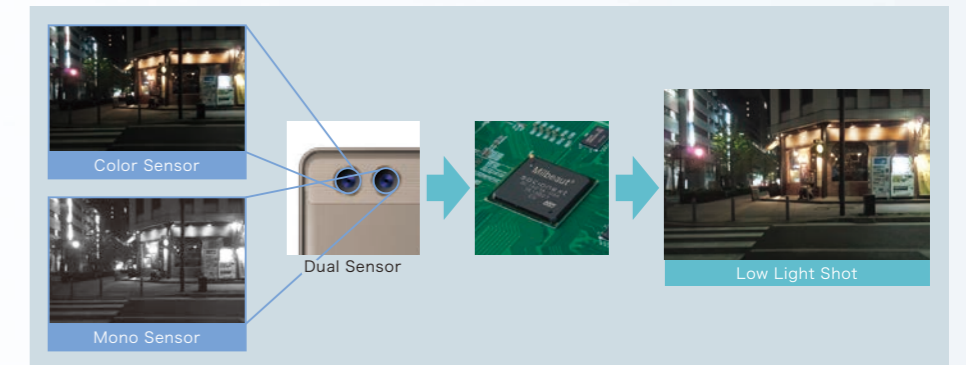

### Super Hybrid AF(AutoFocus)

Realizes high-speed, high-accuracy AF in various scenes by using a hybrid of 3 types of AF.

- Contrast AF
- Phase Detection AF
- Laser AF

Contrast AF relies only on contrast values calculated per frame, thus takes too much time focusing in low-light conditions where frame rate falls. Hybrid AF automatically select AF algorithm that best fits the scene, such as using Phase Detection AF in basic scenes and laser AF in low-light or macro conditions. This switching allows our AF to operate at high-speed and high-accuracy.

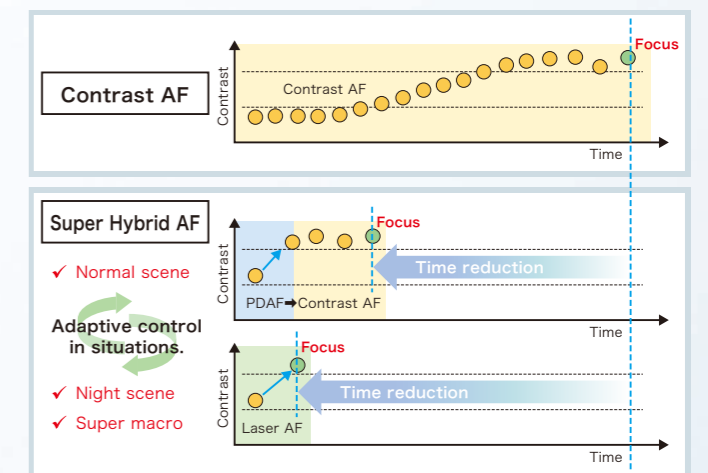

## Product Lineup

### Milbeaut®

Product	Features
MBG967	16M/30, Dual Camera, PDAF
MBG965	13M/30
MB86S29	16M/30, PDAF

## Major IPs

- Super Hybrid AF
- Dual Camera IP
- Color Correction
- Brightness Control
- Face Detection
- Video Image Stabilization

# Digital Camera Solution

Coming upon views or important life events that users cannot miss, it is necessary for digital camera to capture the moment as a beautiful, high-quality image that are beyond imagination. With Milbeaut's top image processing technology accumulated through its history in various fields, we provide the best quality image with high-speed processor that best suit the high expectations for digital camera.



## Application

For Digital Camera Solutions we provide various applications that allow users to capture the best photo in every scene. We powerfully support users to take beautiful photos/videos without complexity, given that high-quality images at high-speed are expected for latest digital cameras.

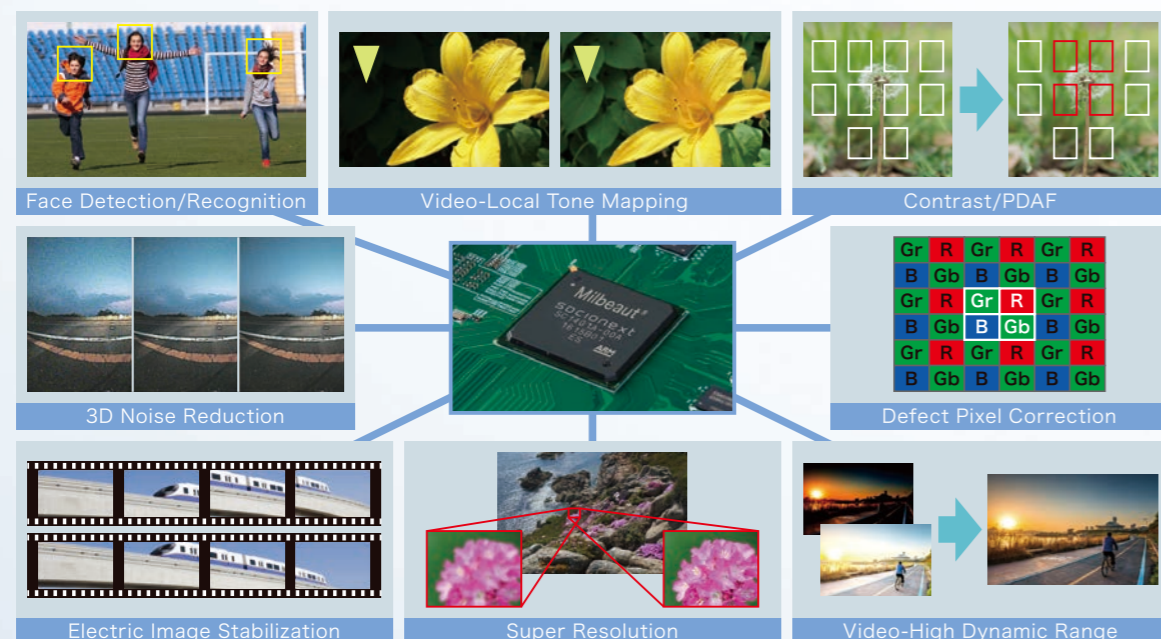

## Main Features

### Lens Distortion Correction

Lens distortion correction is processed at high-speed using hardware.



### Local Tone Mapping

Improves visibility by adopting the dynamic compression technique, analyzing the image locally. This technology converts an image with wide dynamic range to narrow dynamic range that matches the high contrast to output medium.

### Noise Reduction

Reduces luminance/color noise efficiently using the high-performance filter included in hardware. This is most effective in scenes with low luminance.

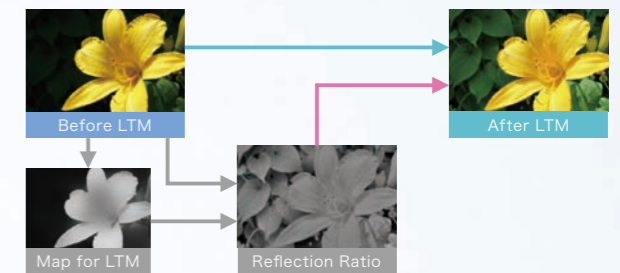

### 3D Noise Reduction(3DNR)

Milbeaut 3DNR, making use of our motion detection and compensation technology, can realize powerful noise reduction for objects in motion without any motion blur/ghost.

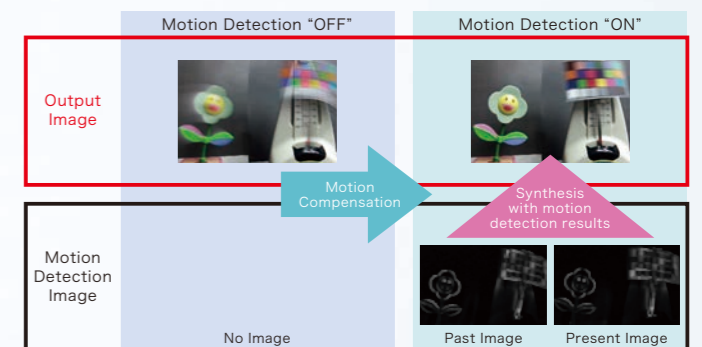

### Video HDR / Still HDR

HDR feature prevents under/over exposures and captures more vivid and detailed image in difficult scenes such as backlight, high contrast, and night scenes. Available for both Still and Video captures up to 30fps in full HD size.

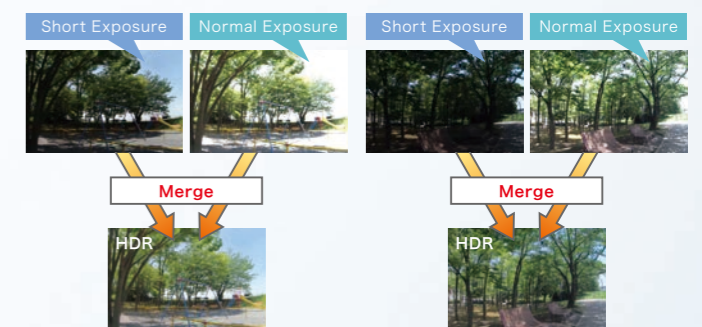

## Product Lineup

### Milbeaut®

Product	Features
MB86S22	1080/60i, H.264
MB86S27	4K/30p, H.264, 360° distortion correction
MB91696B	1080/30p, H.264

## Major IPs

- EIS (Electronic Image Stabilization)
- Video HDR
- Face Detect/Recognition
- Haze Density Detection (Auto)
- Haze Removal/Correction
- 3DNR
- Noise Reduction
- Optimization of High Sensitivity