

DTV Front-end LSI for Smartphone/ Mobile MN88553

■ Overview

“MN88553” is a system LSI supporting world-wide terrestrial broadcast systems (ISDB-T, ISDB-Tsb, ISDB-Tmm, and DVB-T).

With the monolithically integrated low-power RF tuner, high-performance OFDM demodulator, and error correction, this product outputs transport stream (TS) data.

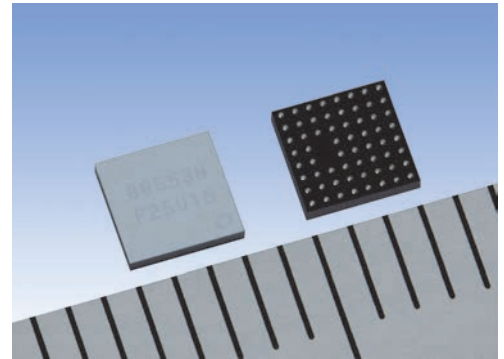

■ Features

- Designed for low noise and optimized for mobile use, this system LSI is resistant to mobile and multi-path environments, and have the best performance* in the industry.
- With the integrated RF tuner, it achieves the industry's lowest power consumption* and minimizes total BOM count. This small-sized product contribute to improving the competitiveness of products for smartphones, tablets, and accessory devices.
- Supports the broadcast systems in many countries of the world, and have a built-in demodulator with an extensive proven track record in the market.
- I²C/ SPI etc. bus-compliant CPU interface.
- Supports for AC emergency alert.

* Based on our survey in January 2016

■ Applications

Smartphone/ Tablet



Portable TV/ Wi-Fi Tuner



■ Specifications

Function		Specifications	
TV Standards	ISDB-T ISDB-Tsb ISDB-Tmm	Bandwidth	6, 7, 8 MHz <i>* Include connected segment.</i>
		FFT size	2K (Mode1), 4K (Mode2), 8K (Mode3)
		Guard interval length	1/32, 1/16, 1/8, 1/4
		Carrier modulation scheme	QPSK, 16QAM, 64QAM, DQPSK
		Convolutional-coding rate	1/2, 2/3, 3/4, 5/6, 7/8
	DVB-T	Bandwidth	6, 7, 8 MHz
		FFT size	2K, 4K, 8K
		Guard interval length	1/32, 1/16, 1/8, 1/4
		Carrier modulation scheme	QPSK, 16QAM, 64QAM
		Convolutional-coding rate	1/2, 2/3, 3/4, 5/6, 7/8
RF frequency		UHF (470MHz~860MHz) / VHF-H (207.5MHz~222MHz) / VHF-L (95MHz~108MHz) * <i>Example in Japan</i> CATV (90MHz~770MHz)	
Function	CPU Interface	I ² C bus based CPU interface, SPI, SDIO, Parallel	
	TS Interface	TS serial/ parallel, SPI (Up to 50Mbps), SDIO, Parallel	
	Diversity	Available using 2 chips	
	Monitoring	RSSI, C/N, BER, PER, TMCC, AC etc.	
Process		CMOS	
Package		0.4mm pitch WLCSP 62pin	
Supply Voltage		IO: 1.5V-3.6V Logic: 1.1V (Typ.) Analog: 1.5V (Typ.) <i>* It can be single voltage operation with on-chip regulator.</i>	

■ Block Diagram

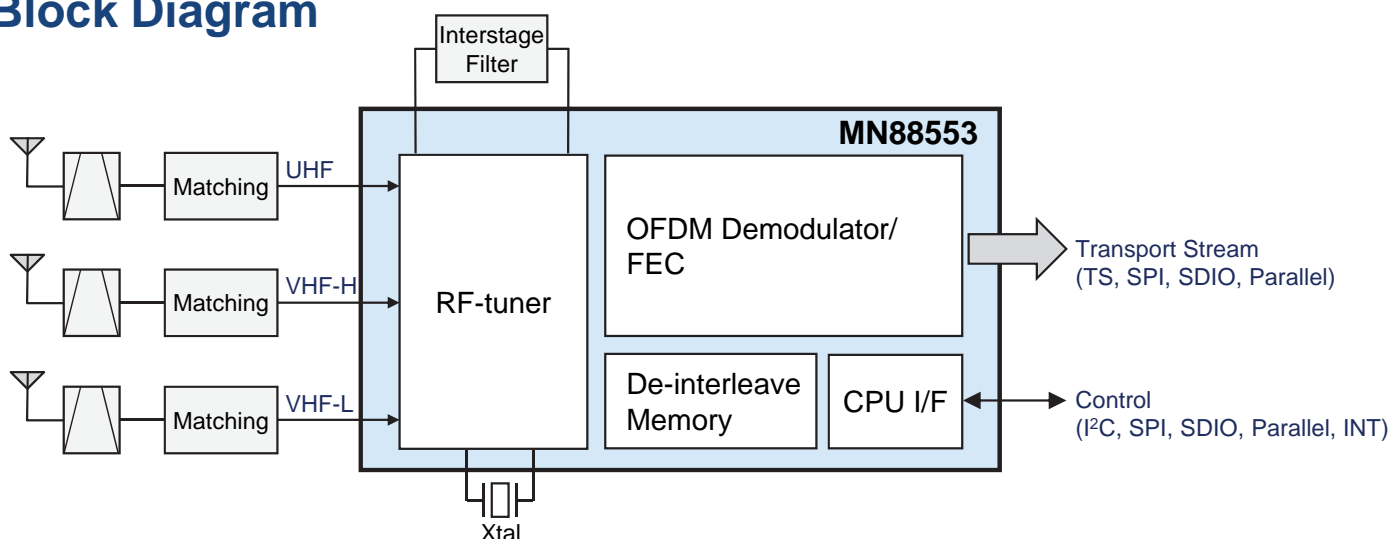

The Products and product specifications described in this document are subject to change without notice for modification and/or improvement. At the final stage of your design, purchasing, or use of the products, therefore, ask for the most up-to-date Product Standards in advance to make sure that the latest specifications satisfy your requirements. All company names, brand names and trademarks herein are property of their respective owners.

Copyright 2016 Socionext Inc.

AD04-00090-1E June 2016

Edited : IoT and Graphics Solution Business Unit

Socionext Inc.

Nomura Shin-Yokohama Bldg.,

2-10-23 Shin-Yokohama,

Kohoku-ku, Yokohama, Kanagawa, 222-0033, Japan

Tel. +81-45-568-1015

<http://socionext.com>